

Kommander-KA04

Aluminum 600W compact amplifier and processing solution

USER GUIDE



• 20230529 •



K-ARRAY
Unique Audio Solutions

This page intentionally left blank

IMPORTANT SAFETY INSTRUCTIONS



CAUTION

RISK OF ELECTRIC SHOCK
DO NOT OPEN



ATTENTION: RISQUE DE CHOC ELECTRIQUE NE PAS OUVRIR

CAUTION: TO REDUCE THE RISK OF ELECTRIC SHOCK,
DO NOT REMOVE COVER (OR BACK).
NO USER-SERVICEABLE PARTS INSIDE.
REFER SERVICING TO QUALIFIED SERVICE PERSONNEL.



This symbol alerts the user to the presence of recommendations about the product's use and maintenance.



The lightning flash with arrowhead symbol within an equilateral triangle is intended to alert the user to the presence of uninsulated, dangerous voltage within the product enclosure that may be of magnitude to constitute a risk of electrical shock.



The exclamation point within an equilateral triangle is intended to alert the user to the presence of important operating and maintenance (servicing) instructions in this guide.



Operator's manual; operating instructions
This symbol identifies the operator's manual that relates to the operating instructions and indicates that the operating instructions should be considered when operating the device or control close to where the symbol is placed.



For indoor use only
This electrical equipment is designed primarily for indoor use.



WEEE
Please dispose of this product at the end of its operational lifetime by bringing it to your local collection point or recycling center for such equipment.



This device complies with Restriction of Hazardous Substances Directive.

WARNING



Failure to follow these safety instructions could result in fire, shock or other injury or damage to the device or other property.

General heed and warnings

- Read these instructions.
- Keep these instructions.
- Heed all warnings.
- Follow all instructions.
- Do not use this apparatus near water.
- Clean only with dry cloth.
- Do not block any ventilation openings. Install in accordance with the manufacturer's instructions.
- Do not install near any heat sources such as radiators, heat registers, stoves, or other apparatus (including amplifiers) that produce heat
- Do not defeat the safety purpose of the polarized or grounding plug. A polarized plug has two blades with one wider than the other. A grounding plug has two blades and a third grounding prong. The wide blade or the third prong is provided for your safety. If the provided plug does not fit into your outlet, consult an electrician for replacement of the obsolete outlet.
- Only use attachments/accessories specified by the manufacturer.
- Protect the power cord from being walked on or pinched particularly at the plugs, convenience receptacles, and at the point where they exit from the apparatus.
- Clean the product only with a soft and dry fabric. Never use liquid cleaning products, as this may damage the products cosmetic surfaces.
- Use only with the cart, stand, tripod, bracket, or table specified by the manufacturer, or sold with the apparatus. When a cart is used, use caution when moving the cart/apparatus combination to avoid injury from tip-over. 
- Unplug this apparatus during lightning storms or when unused for long periods of time.
- Avoid placing the product in a location under direct sunlight or near any appliance that generates UV (Ultra Violet) light, as this may change the product surface finishing and cause a change in color.
- Refer all servicing to qualified service personnel. Servicing is required when the apparatus has been damaged in any way, such as power-supply cord or plug is damaged, liquid has been spilled or objects have fallen into the apparatus, the apparatus has been exposed to rain or moisture, does not operate normally, or has been dropped.
- **CAUTION:** These servicing instructions are for use by qualified service personnel only. To reduce the risk of electric shock, do not perform any servicing other than that contained in the operating instructions unless you are qualified to do so.
- **WARNING:** Only use attachments/accessories specified or provided by the manufacturer (such as the exclusive supply adapter, battery, etc.).
- **WARNING:** Operation of this equipment in a residential environment could cause radio interference.

This apparatus is intended for professional use.

Installation and commissioning may only be carried out by qualified and authorized personnel.

Kommander-KA04

USER GUIDE

- Before turning the power on or off for all devices, set all volume levels to minimum.
- Use only speaker cables for connecting speakers to the speaker terminals. Be sure to observe the amplifier's rated load impedance particularly when connecting speakers in parallel. Connecting an impedance load outside the amplifier's rated range can damage the apparatus.
- K-array cannot be held responsible for damage caused by improper use of the loudspeakers.

CE Statement

K-array declares that this device is in compliance with applicable CE standards and regulations. Before putting the device into operation, please observe the respective country-specific regulations!



FCC Statement

This equipment has been tested and found to comply with the limits for a Class B digital device, pursuant to part 15 of the FCC Rules. These limits are designed to provide reasonable protection against harmful interference in a residential installation. This equipment generates, uses and can radiate radio frequency energy and, if not installed and used in accordance with the instructions, may cause harmful interference to radio communications. However, there is no guarantee that interference will not occur in a particular installation. If this equipment does cause harmful interference to radio or television reception, which can be determined by turning the equipment off and on, the user is encouraged to try to correct the interference by one or more of the following measures:



1. Reorient or relocate the receiving antenna.
2. Increase the separation between the equipment and receiver.
3. Connect the equipment into an outlet on a circuit different from that to which the receiver is connected.
4. Consult the dealer or an experienced radio/TV technician for help.

FCC Radiation Exposure Statement

This device complies with FCC radiation exposure limits set forth for an uncontrolled environment. This equipment must be installed and operated in accordance with provided instructions and the antenna(s) used for this transmitter must be installed to provide a separation distance of at least 20 cm from all persons.

This device complies with Part 15 of the FCC Rules. Operation is subject to the following two conditions:

1. this device may not cause harmful interference, and
2. this device must accept any interference received, including interference that may cause undesired operation.

CAUTION! Any changes or modifications not expressly approved by the party responsible for compliance could void the user's authority to operate the equipment.

CE Statement

This device complies with Industry Canada's licence-exempt RSSs. Operation is subject to the following two conditions:

- this device may not cause interference, and
- this device must accept any interference, including interference that may cause undesired operation of the device.

The device meets the exemption from the routine evaluation limits in section 2.5 of RSS 102 and compliance with RSS-102 RF exposure, users can obtain Canadian information on RF exposure and compliance.

This equipment should be installed and operated with a minimum distance of 20 centimeters between the radiator and your body.

Trademark Notice

All trademarks are the property of their respective owners.

Index

Unpacking	6	Dashboard	13
Kommander-KA04 Rear Panel	6	USB Media Player	13
Software	6	Bluetooth Media Player	13
Introduction	7	Webradio Media Player	13
K-array Connect Mobile App	7	DanteReady™ streamer	13
Getting Started	7	Device preset	13
Mounting and cooling	8	Audio Configuration	14
AC MAINS supply	8	Output Configuration	14
LED chart	8	MATRIX	15
Status LED	8	INPATCH	15
Input wiring	9	Network	15
Loudspeaker wiring	9	WiFi	15
K-REMUCTRL Remote	10	Ethernet	15
Configuring The Remote Settings	10	Advanced	16
Remote Connectivity	11	System Update	16
Connectivity Reset	11	K-framework3	17
K-array Connect Mobile App	12	Service	18
Connecting To The Built-In Hot Spot	12	Cleaning	18
Embedded Web App	13	Mechanical Drawing	19
		Specifications	20

Kommander-KA04

USER GUIDE

This page intentionally left blank

Thank you for choosing this K-array product!

To ensure proper operation, please carefully read the owner's manuals and safety instruction before using the products. After reading this manual, be sure to keep it for future reference.

Should you have any questions about your new device please contact K-array customer service at support@k-array.com or contact the official K-array distributor in your country.

The Kommander-KA04 is a fully featured 4x150W @ 4Ω class-D amplifier with a high-performing DSP. The digital processing multi-channel amplifier is designed for optimized performance in small to medium loudspeaker systems.

The Kommander-KA04 implements the Integrated Electronic Brain (IEB) technology with oskar custom operating system running on quad-core 1.5 GHz internal processor.

The K-array Connect mobile app provides the control dashboards to access all Kommander-KA04 DSP features for system settings, fine tuning and monitoring.

Kommander-KA04

USER GUIDE

Unpacking

Each K-array amplifier is built to the highest standard and thoroughly inspected before leaving the factory.

Upon arrival, carefully inspect the shipping carton, then examine and test your new amplifier. If you find any damage, immediately notify the shipping company. Check that the following parts are supplied with the product.

- A. 1x Kommander-KA04 amplifier unit
- B. 2x Output channel flying connectors
two terminals Euroblock 2,5/ 2-ST-5,08
- C. 1x Output channel flying connector
four terminals Euroblock 2,5/ 4-ST-5,08
- D. 4x Balanced input flying connectors
three terminals Euroblock 1,5/ 3-ST-3,81
- E. 1x Power cord
- F. 1x Quick guide

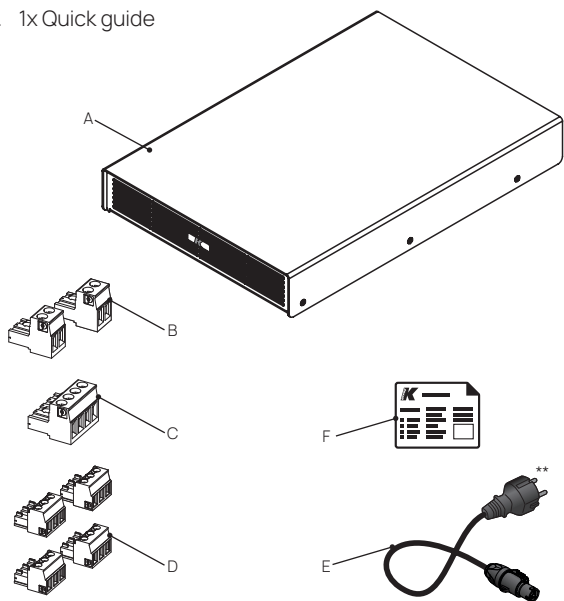

Note

** The AC mains cord plug may differ from the picture according to local regulation.

Kommander-KA04 Rear Panel

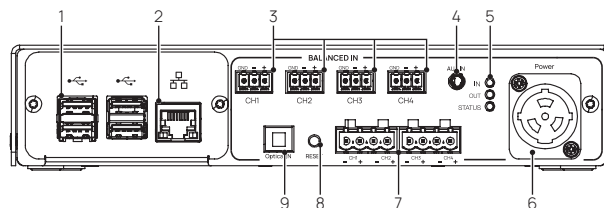

- 1. 4x USB ports
- 2. RJ45 Ethernet port
- 3. 4 channels Euroblock 1,5/ 3-ST-3,81 balanced analog inputs
- 4. 3,5 mm jack unbalanced stereo analog input
- 5. Status LEDs
- 6. AC MAINS PowerCON connector
- 7. 4 channels Euroblock output terminals: speaker connectors for either 2,5/ 2-ST-5,08 or 2,5/ 4-ST-5,08 flying plugs
- 8. Reset button
- 9. Optical S/P DIF stereo digital input

Software

The dedicated K-array Connect app and the K-framework3 software for Mac and PC allow the user to access to the highly configurable output section and the powerful DSP making any Kommander-KA02I amplifier a flexible driving unit.



WINDOWS and OSX software
K-framework3

click to go



Introduction

The Kommander-KA04 is a 1RU amplifier unit with an incredibly compact size of 219 x 46 x 320 mm (8.6 x 1.8 x 12.6 in), full featured DSP and the backing of 600W for small to medium size application.

The amplifier features four balanced analog inputs and a fiber optical input working up to 192 kHz. It boasts Bluetooth connectivity, mini jack input and USB ports for using MP3, WAV, FLAC, AAC, ecc., files.

Enhanced performance and easy tuning are managed by the Integrated Electronic Brain – IEB – implemented into the amplifier unit. More than a traditional DSP, the built-in micro electronics driven by the integrated operating system osKar features expansive sound processing – input gain, signal routing matrix, delay, full parametric IIR filters (Peaking, Shelving, Hi/Lo pass, Hi/Lo Butterworth) and on-board preset –, offering complete user control over the system performance.

Getting Started

1. Connect the input and output signal cables according to the configuration you want to achieve.
2. Connect the Kommander-KA04 to its power supply and plug the power cord to the AC mains socket.
3. Use the K-array Connect app to connect your mobile device to the Kommander amplifier unit
4. Set the amplifier Output Configuration*: the Devices menu will show the device(s) you can manage with the app: press on the image of the unit to configure.



Carefully check that the factory presets match the actual configuration of passive speakers connected to the amplifier connectors.

5. Set the signal routing from the input channels to the output channels in the ROUTING tab.
6. Check the signal volume in the VOLUMES tab.
7. Enjoy K-array sound!

K-array Connect Mobile App

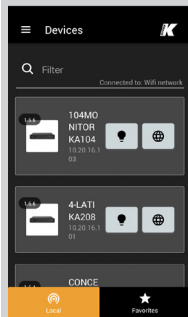

Discovery

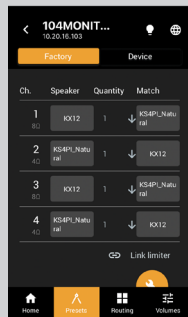

Output Configuration

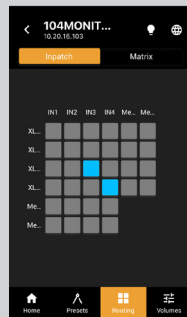

INPATCH

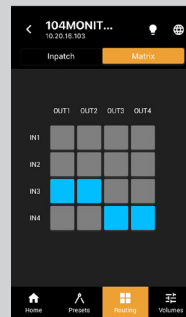

MATRIX



Output Volumes

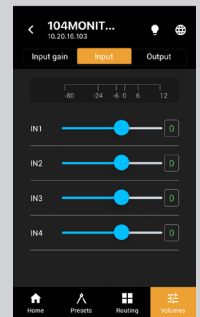

Input Volumes

Kommander-KA04

USER GUIDE

Mounting and cooling

The Kommander-KA04 amplifier and processing unit can be set stand alone or installed into rack cabinets with the K-RACK24 rack-mounting hardware accessory.

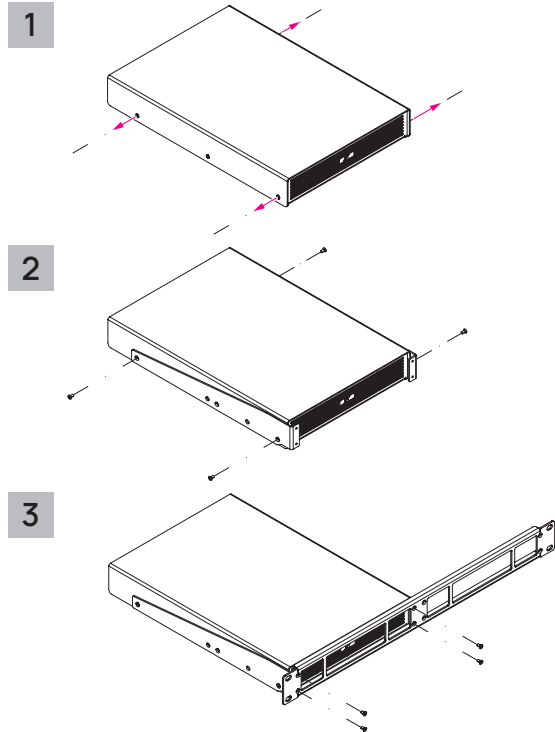

1. Unscrew the first and the third lateral screw on each side of the Kommander-KA04 chassis.
2. Use the screws included in the K-RACK24 package to fix the lateral brackets to the Kommander-KA04 chassis.
3. Fix the brackets to the front panel.

The K-RACK24 rack-mounting accessory suites two Kommander-KA4 units in 1U.

Install the amplifier in a well-ventilated location: the ventilation openings must not be impeded by any item.

Fresh air enter the amplifier from the bottom plate, warm air is expelled from the front panel.

AC MAINS supply

The AC Main connection is made via the provided power cord: insert the powerCon TRUE flying connector into the inlet and then rotate it clockwise.

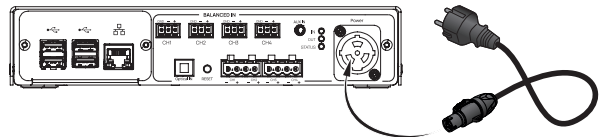

Once properly plugged, the amplifier power up: the front and back status LEDs light on.

LED chart

In the rear panel, the input signal monitor LED and the output signal monitor LED blink according to the presence of audio signal at any input or output channel respectively. The input and output signal monitor LEDs light on orange when the DSP is limiting the signal level.

Status LED

Color	Mode	Description
orange	solid	DSP software is loading
green	solid	System ready
blue	solid	User command: system identification
purple	flashing	Network parameters reset

Kommander-KA04

USER GUIDE

K-REMUCTRL Remote

K-REMUCTRL is the optional wireless remote dedicated to control the Kommander-KA04 amplifier unit.

In order to use the K-REMUCTRL with the Kommander-KA04 amplifier:

1. ensure the system software is up to date;
2. pull out the dongle from the K-REMUCTRL remote package;
3. plug the dongle to any free USB port on the amplifier rear panel;
4. switch on both the amplifier and the K-REMUCTRL remote.

The K-REMUCTRL remote includes a high-efficiency rechargeable battery with a switch that can extend the battery life when powered off.

When the battery discharges to approximately 10% remaining life, the Status LED begins flashing: connect the remote's charge port to a standard USB port to recharge the internal battery; use the provided cable.

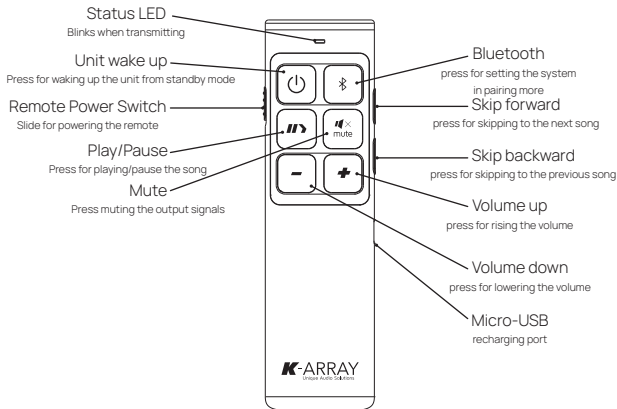

By default the K-REMUCTRL remote works on the media player volume only: in order to modify the behaviour of the remote controller access the embedded web app.

Configuring The Remote Settings

Once the K-REMUCTRL's dongle is plugged to the amplifier, the logo of the remote will appear in the upper right corner of the embedded web app interface.

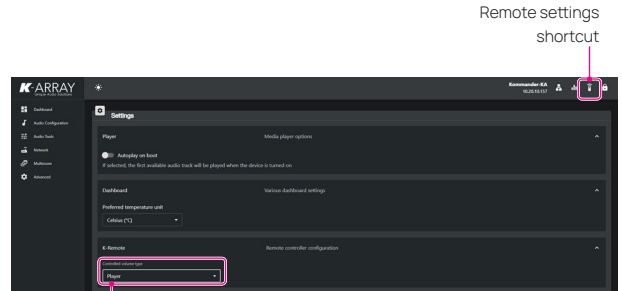

Controlled volume type

Select what part of the system the K-REMUCTRL will control: either the media player volume, or the DSP intup/output channels volumes

Access the amplifier embedded web app and click on the remote settings icon in the top right corner.

Navigate the interface down to the K-Remote section.

The remote can control either the embedded media player (default setting) or the DSP: use the Controlled volume type selection field to choose what to control.

When DSP is selected, you can set what channels volumes between input channels or output channels will be controlled by the remote.

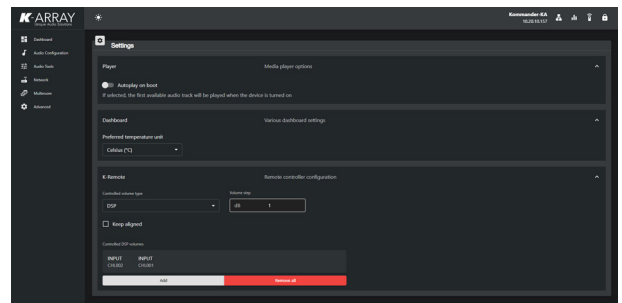

Remote Connectivity

The Kommander-KA04 amplifier features a built-in hot spot establishing a local Wi-Fi network dedicated to remote control the amplifier with mobile devices.

The default local Wi-Fi SSID and unit IP address are printed on a label located on the rear plate of the unit; a QR code for easing the connectivity is printed as well.

The RJ45 Ethernet port on the rear panel allows to connect the unit to a local area network (LAN). Since every host on a network must be identified by a unique IP address, the simplest local network usually implement a router/switch with a DHCP server managing the addresses allocation: by default the Kommander-KA unit is set to obtain a local IP address from the DHCP server.

In case a DHCP server is not present on the LAN, the unit goes in AutoIP mode: in few seconds the amplifier automatically self-assign an IP address in the range 169.254.0.0/16.

A static IP address can be assigned to the amplifier unit using the amplifier's embedded web app (Network menu).

Connectivity Reset

With the unit switched on, keep pressed the RESET button on the rear panel for 10 to 15 seconds in order to:

- Revert the wired IP addressing to DHCP;
- Activate the built-in Wi-Fi and reset the wireless parameters to the default SSID name and password

The status LED turns purple while the RESET button is pressed.

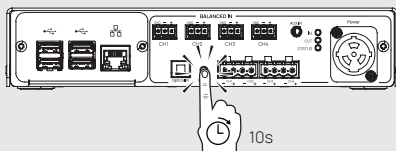

The Kommander-KA04 amplifiers can be controlled remotely by a mobile device or desktop PC/MAC.

K-array Connect mobile app

K-array Connect is the mobile app that allows to direct manage and control a Kommander-KA amplifier with a mobile device (smartphone or tablet) wireless.

Download the K-array Connect mobile APP from the dedicated store of your mobile device.



Embedded web app

The integrated operating system osKar features a complete web user interface accessible over the network: connect to the Kommander-KA04 on a local network or wireless via its built-in hot spot and access the web app with a web browser (Google Chrome recommended).

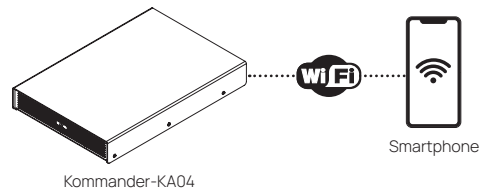

K-framework3

The K-array K-framework3 is the managing and control software dedicated to professionals and operators looking for a powerful tool for designing and managing a large number of units in demanding applications. Download the K-framework3 software from K-array website.

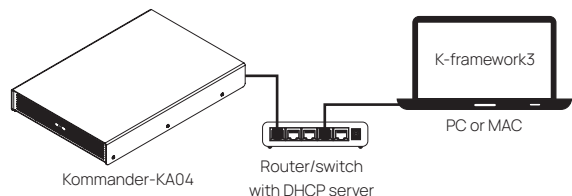

Kommander-KA04

USER GUIDE

K-array Connect Mobile App

The K-array Connect mobile app allows to access the Kommander-KA04 amplifier unit wireless, leveraging on the local Wi-Fi established by the built-in hot spot.

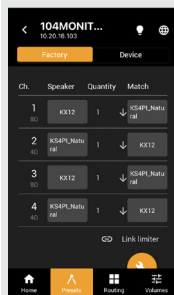
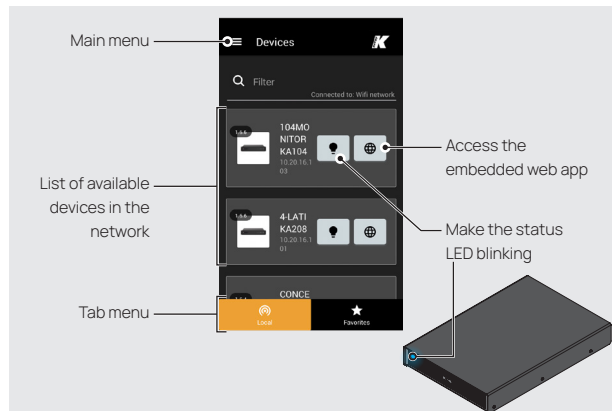

Preset menu
Load the loudspeaker factory presets on the output channels and manage the device configuration presets.

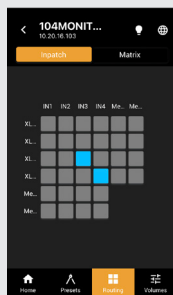

Routing menu
Patch the input signals to the DSP inputs.

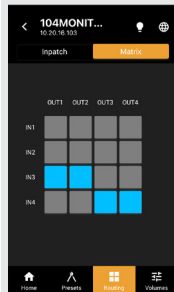

Preset menu
MATRIX
Set the signal routing from the DSP to the output connectors.

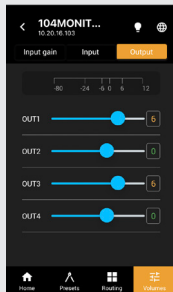

Volumes menu
Manage the the input and output volumes.

Connecting To The Built-In Hot Spot

1. Ensure the Wi-Fi of the mobile device is on.
2. Launch the K-array Connect app.
3. If the list of available devices is empty touch the SCAN QR CODE button and use the mobile device camera to frame the QR code in the bottom panel of the Kommander-KA unit: this provides the mobile device to connect to the amplifier's hot spot.
4. Click on the image of the Kommander-KA unit to manage the amplifier with the K-array Connect app or click on the button with the globe in order to launch the embedded web app.



In case you need to connect manually connect to the amplifier's hot spot, the default password is the device serial number, e.g. K142AN0006 (case sensitive).

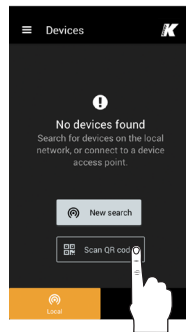

Scroll down to update the list of devices or touch the Scan QR code button to activate the camera in order to connect the unit

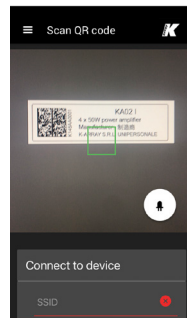

The K-array active unit has a label with the QR code for connecting the local Wi-Fi: target the code to establish the wireless connection



Connected and discovered!

Embedded Web App

The embedded web app provides direct access to the operating parameters of the amplifier unit.

The web app is accessible via a web browser (Google Chrome recommended) over a wired or wireless connection to the amplifier unit.

The K-array Connect Mobile App and the K-framework3 software interfaces include a shortcut for opening the web app, once the connection to the amplifier unit is established.

If the amplifier unit is connected to a LAN and its IP address is set and known, it is possible to access its embedded web app typing its IP address in the address bar of the web browser.



The default menu provides access to the media player and the amplifier unit setup parameters.

USB Media Player

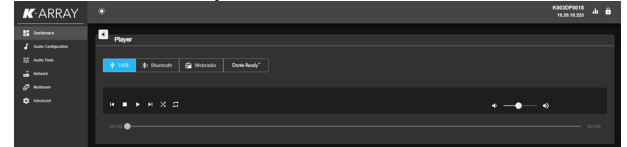

Bluetooth Media Player

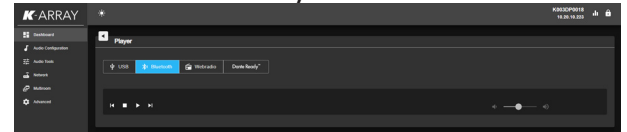

Webradio Media Player

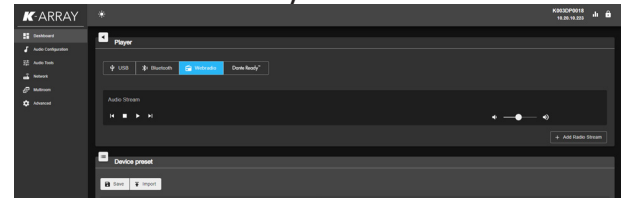

Dashboard

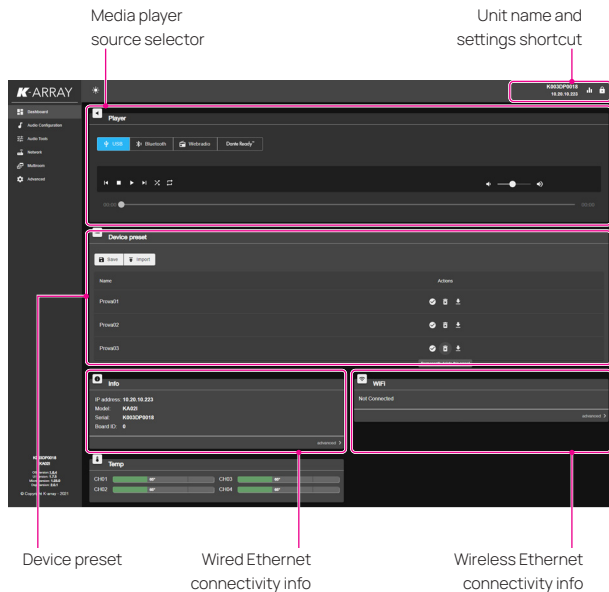

DanteReady™ streamer

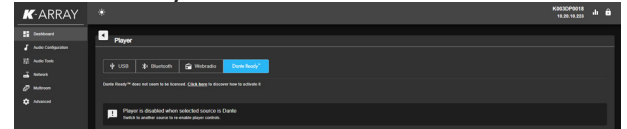

The units born with no active Dante channels and can be upgraded to 2 IN x 2 OUT Dante channels (Ships with 0x0 / Upgradeable to 2x2).

Customers can make channel purchases directly within Dante Controller using Audinate's payment system.

Device preset

This tab contains the slot where to manage (save, import, export, delete) the unit configuration.

Kommander-KA04

USER GUIDE

Audio Configuration

Use this menu to access the input/output signal routing and output configuration

Output Configuration

The Output Configuration is where the K-array loudspeaker factory presets can be loaded on the output channels.

By default, all Kommander-KA units born with all the amplifier's output connections muted: in order to activate the output channels the output configuration shall be set.

Care must be taken matching the loudspeaker presents with the actual loudspeaker configuration.

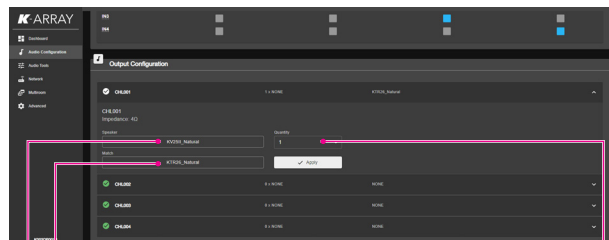

Loudspeaker Preset

Select the factory loudspeaker preset matching the actual loudspeaker model and version connected to this output channel

Loudspeaker in parallel

Select the number of loudspeakers connected in parallel to this output channel

Matched Loudspeaker

Select the factory loudspeaker preset matching the subwoofer or mid/high loudspeaker used in the actual configuration: this parameter sets the frequency crossover point.

1. Navigate the menu and go to Audio Configuration.
2. Go to the Output Configuration section.
3. Select the output channel to be configured.
4. Select the speaker factory preset corresponding to the loudspeaker model and version actually connected to the amplifier output connector.
5. If needed, set the number of loudspeakers that are connected in parallel to the amplifier output connector.

6. Select the matching loudspeaker, i.e. the subwoofer used in the actual loudspeaker configuration (eg. the Truffle-KTR26 matching the Vyper-KV25II) or the high/mid loudspeaker when configuring a subwoofer output channel (eg. the Lizard-KZ14I matching the Truffle-KTR25).
7. Apply the output channel configuration.
8. Go to the Routing section and set the proper signal routing.

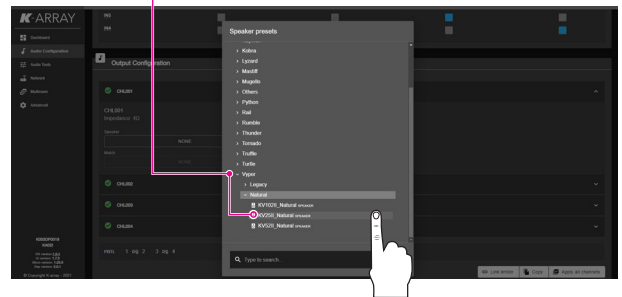
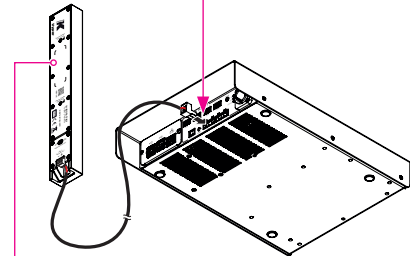
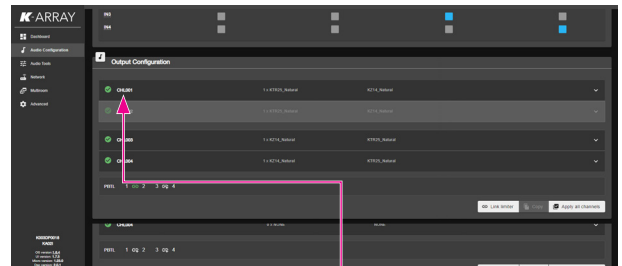

Ensure to set the proper loudspeaker factory preset corresponding to the actual loudspeaker connected to the amplifier output channel

MATRIX

The matrix allows to set the signal routing path between the four amplifier's input channels and the four amplifier's output connectors.

Blue boxes at the cross intersection between rows and columns state an open path between sources (raw) and destinations (columns).

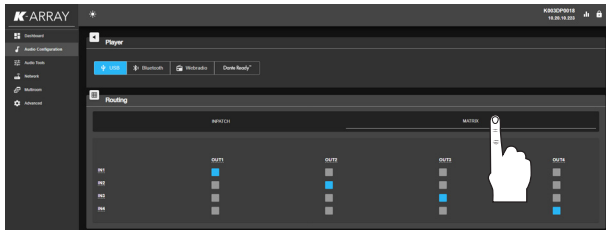

INPATCH

The input patch tab allows to address the input connections and the input streamer (media player) to the four amplifier's input channels.

The signal managed by the media player can be routed to the amplifiers' input channels via the Media-1 OUT and Media-2 OUT.

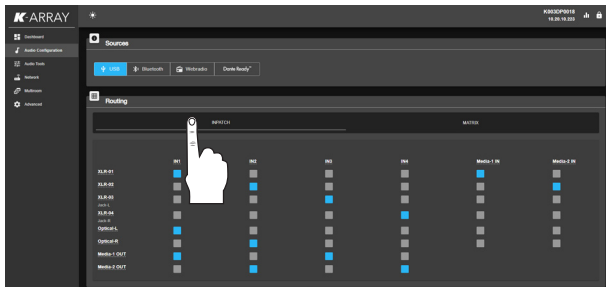

Network

This menu section allows the user to monitor and set the network parameters both wired, wireless and Bluetooth.

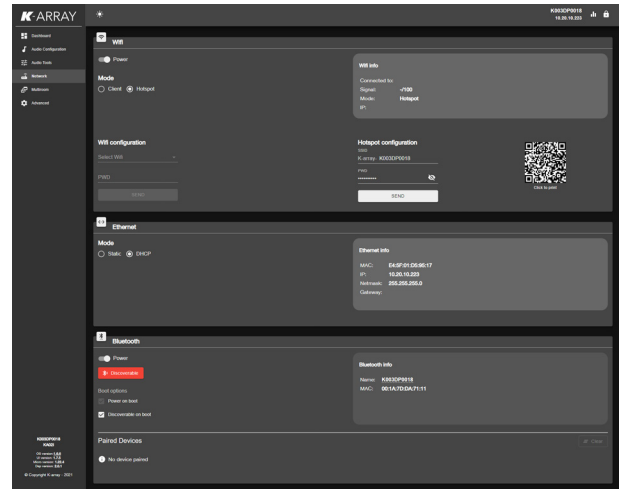

WiFi

The WiFi can be configured to connect the unit to a wireless LAN as a CLIENT or, alternatively, to create an independent local wireless network behaving as HOT SPOT.

By default the WiFi is set as HOT SPOT allowing any mobile device to connect to the unit.

By default, the SSID of the HOT SPOT is composed by the word "K-array-" followed by the serial number of the unit; the default password is the unit's serial number. The SSID and the password of the HOT SPOT can be modified manually: the QR Code will change accordingly.

When set as CLIENT, enter the data of the WiFi LAN in order to connect the unit to that network.

The power switch allows to toggle on and off the WiFi.

Ethernet

Set the IP addressing static or DHCP.

Kommander-KA04

USER GUIDE

Advanced

This menu provides access to the system informations, like the device name and ID and the system update tool.

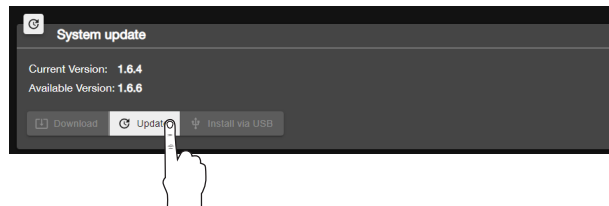
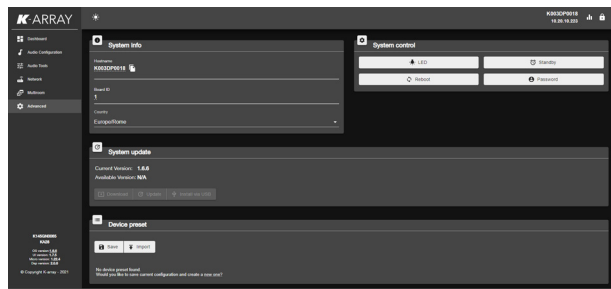

The update procedure lasts in about 15 minutes: after updating the Kommander-KA04 amplifier unit reboots.

Update via USB

- A. Make a folder named update (case sensitive) on the root of a USB key or drive.

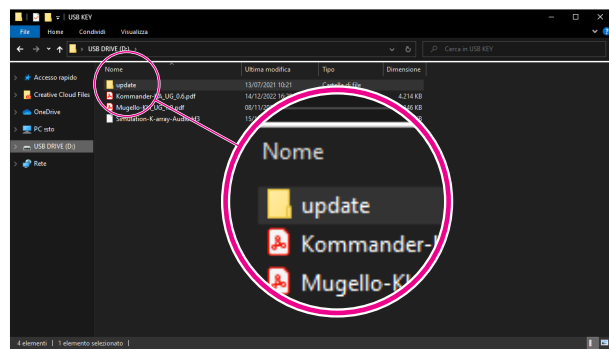

System Update

In order to update the internal DSP software and osKar operating system two methods are available: via an Internet connection or USB key.

Update via Internet

1. Connect the Kommander-KA amplifier to Internet – possibly via a wired connection.
2. The Download button turns active when a new software version is available on K-array server: when active, press on the Download button to start downloading the software from the Internet. This step doesn't install the software: the installation shall be actiated manually.

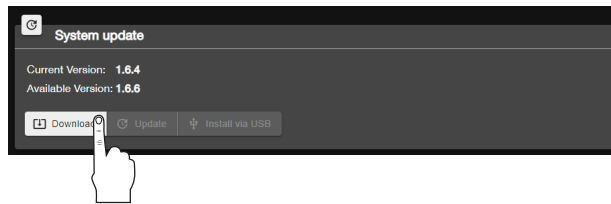

3. The Update button activates when the software is completely downloaded: when active, press on the Update button to start updating the Kommander-KA amplifier.

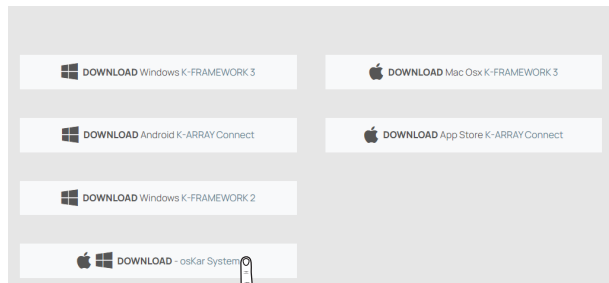

- B. Open the K-array website on the Internet browser on your PC or Mac.
- C. Navigate the Products→Software menu and scroll down to the Download section of the Software webpage.
- D. Download the osKar System (ensure to be registered to the website in order to proceed with the download) and save the update file with extension .mender into the update folder on the USB drive.
- E. Plug the USB drive to a free USB port on the amplifier rear panel.

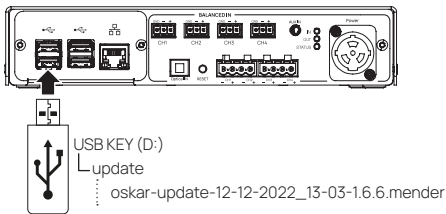

- F. If not already operating, switch on the Kommander-KA amplifier.
- G. Connect your mobile device to the Kommander-KA amplifier and access the embedded web app.
- H. Navigate the user interface to the Advanced menu: the Install via USB button activates when the USB drive contains the .mender file in the proper folder.
- I. Press on the Install via USB button to start updating the Kommander-KA unit.



The update procedure lasts in about 15 minutes: after updating the Kommander-KA04 amplifier unit reboots.

K-framework3

The Kommander-KA04 unit can be remotely controlled with the dedicated K-framework3 software available for PC and MAC on K-array website.

The K-framework3 is the managing and control software dedicated to professionals and operators looking for a powerful tool for designing and managing a large number of units in demanding applications.

WINDOWS and OSX software

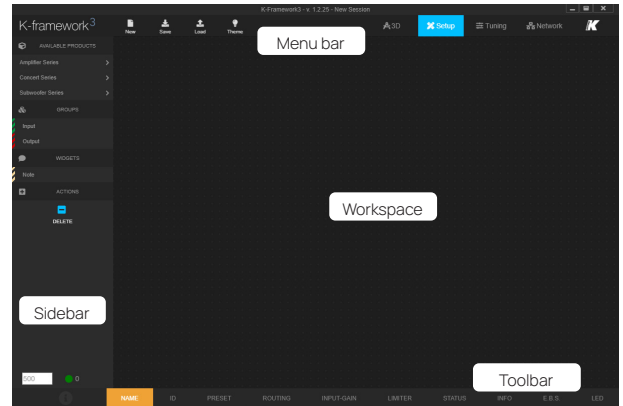

The K-framework3 operates in three modes:

- 3D – Design a loudspeaker system for your venue in a full 3D environment and make free field acoustic simulations;
- SETUP – import from the 3D design the active components into the workspace or build from scratch a PA system composed of active loudspeakers and amplifiers; use the input and output groups to allow full control of the system;
- TUNING – Manage and control the loudspeaker system in real time: optimize the performance of the loudspeaker system during the tuning session and control its behavior in live events.

The K-framework3 can work either off-line with virtual devices or on-line with real active loudspeakers and amplifiers connected over the same Ethernet network.

Kommander-KA04

USER GUIDE

The K-framework3 allows you to start designing the PA system off-line and sync the virtual devices to the real ones on site, when the devices are available, or import from scratch in the workspace the real active loudspeakers and amplifiers available on the network. In both cases, in order to discover and sync the active devices, both the PC or Mac running the K-framework3 and the real units shall be properly connected to the same Local Area Network – LAN – with star topology.

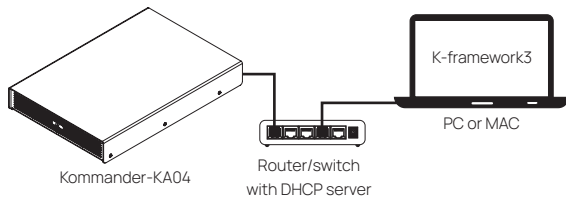

The network shall comprise:

- single PC or MAC, running the K-framework3 software with network interface 100Mbps (or higher);
- router with DHCP server 100Mbps (or higher);
- Ethernet switch 100Mbps (or higher);
- Cat5 (or higher) Ethernet cables.

A DHCP server is highly recommended even if the device units implement the zeroconf network technologies: if a DHCP service is not available, every device will self assign an IP address in the range 169.254.0.0/16 (auto-IP).

Service

To obtain service:

1. Please have the serial number (s) of the unit(s) available for reference.
2. Contact the official K-array distributor in your country: find the Distributors and Dealers list on [K-array website](#). Please describe the problem clearly and completely to the Customer Service.
3. You will be contacted back for on-line servicing.
4. If the problem cannot be resolved over the phone, you may be required to send the unit in for service. In this instance, you will be provided with an RA (Return Authorization) number which should be included on all shipping documents and correspondence regarding the repair. Shipping charges are the responsibility of the purchaser.

Any attempt to modify or replace components of the device will invalidate your warranty. Service must be performed by an authorized K-array service center.

Cleaning

Use only a soft, dry cloth to clean the housing. Do not use any solvents, chemicals, or cleaning solutions containing alcohol, ammonia, or abrasives. Do not use any sprays near the product or allow liquids to spill into any openings.

Mechanical Drawing

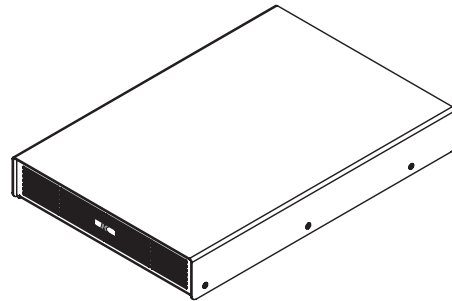
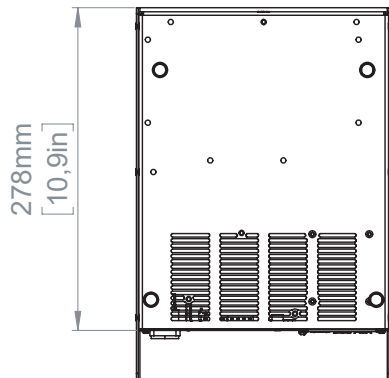
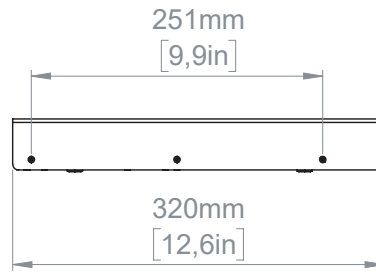
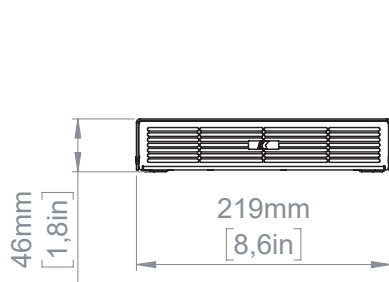

Kommander-KA04

USER GUIDE

Specifications

General	
Type	4ch switching mode, Class D Amplifier
Output Power ¹	4x 150 W @ 4 Ω
Impedance	minimum 4 Ω
Frequency Response	20 Hz - 20 kHz (±1 dB)
Connectors	Input: 4x BAL input: Euroblock 1.5/ 3-ST-3.81, 3.5 mm jack unBAL analog stereo AUX input, TOSLINK optical input, Output: 4x Speaker output over 2x Euroblock 2,5/ 4-G-5,08 Digital: 4x USB-A 2.0, 1x RJ45 Ethernet, Bluetooth 4.1 Low Energy, Wi-Fi IEEE 802.11 b/g/n
Built-in DSP	Grouping, Input EQ, Output EQ, Signal Routing, Level adjustment, Dynamic Limiters, Delay
Remote control	Wi-Fi dedicated K-array Connect mobile app Ethernet wired K-framework3 multiplatform design and tuning software
MAINS Operating Range	100-240V ~ AC, 50-60 Hz
Power Consumption	150 W @ 4 Ω load, Pink noise, 1/8 rated power
Protections	Over Temp. (Power Limiting - Thermal Shutdown), Short Circuit/Overload Output Protection, Power Limiting, Clip Limiter/Permanent Signal Limiter, High Frequency Protection

Handling & Finishes	
IP Rating	IP20
Dimensions (WxHxD)	219 x 46 x 320 mm (8.6 x 1.8 x 12.6 in)
Weight	1,2 kg (2.65 lb)
Material	Aluminum

¹CTA-2006 (CEA-2006) Amplifier Power Standard, single channel driven.



Designed and Made in Italy

K-ARRAY surl

Via P. Romagnoli 17 | 50038 Scarperia e San Piero - Firenze - Italy
ph +39 055 84 87 222 | info@k-array.com

www.k-array.com